

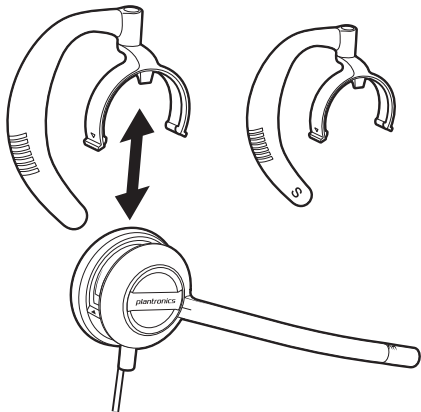

ENCOREPRO 530
ENCOREPRO 530 DIGITAL

HW530/HW530D

plantronics®



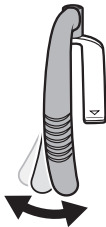
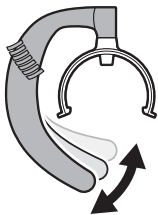
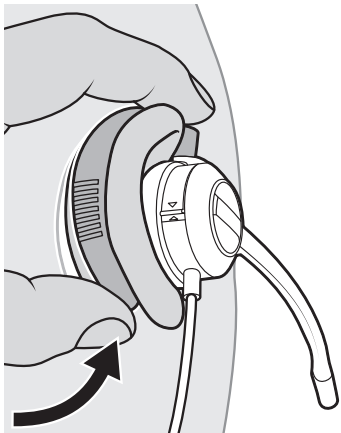

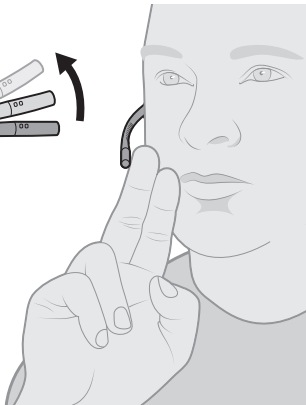
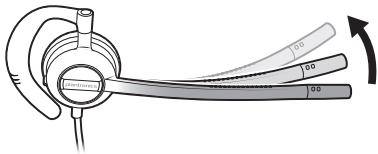

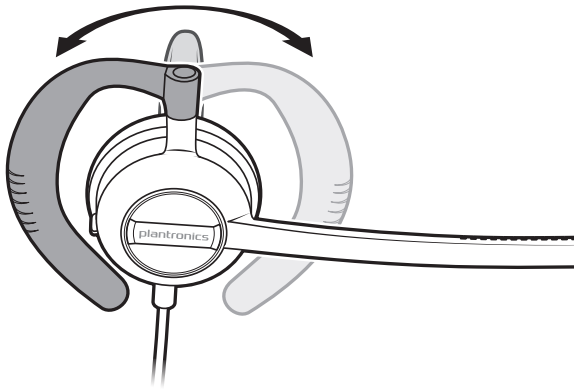



L



R

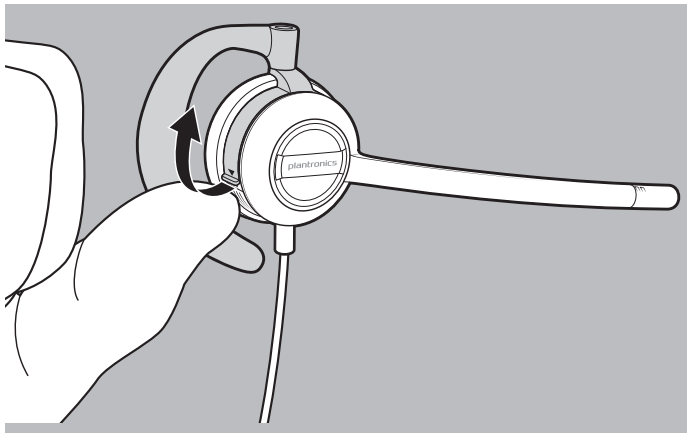



plantronics.com/documentation



plantronics.com/support

Plantronics, Inc.

345 Encinal Street
Santa Cruz, CA 95060
United States

Plantronics BV

South Point Building C
Scorpius 140
2132 LR Hoofddorp
Netherlands

©2016 Plantronics, Inc. EncorePro and Plantronics are trademarks of Plantronics, Inc. registered in the US and other countries. All other trademarks are the property of their respective owners.

Patents: US D717,767; BR 302014001163-4; CN ZL201430055816.5; CO 8123; EM 002426361; IN 261143; MX 43922; TW D167521; patents pending.

206660-01 03.16



Recyclable where
facilities exist