

Backbeat[®] Go 2

plus charge case

User Guide

Contents

Welcome	3
What's in the box	4
Headset overview	5
Charge case overview	6
Pair	7
Get Paired	7
Pair another device	7
Multi-connectivity	7
Charge	9
Check battery level	9
Use charge case	10
Fit	11
The Basics	12
Power the earbuds on or off	12
Audio	12
Adjust the volume	12
Mute	12
Make/Take/End Calls	12
More Features	14
Deepsleep Mode	14
Stay connected	14
Voice alerts	14
Restore factory settings	14
Specifications	15

Welcome

Congratulations on purchasing your new Plantronics product. This guide contains instructions for setting up and using your Backbeat Go 2 earbuds.

Please refer to the safety instructions in the quick start guide for important product safety information prior to installation or use of the product.

What's in the box

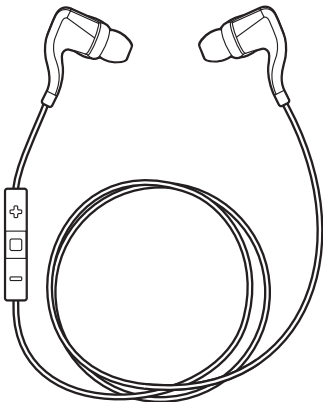

Earbuds with microphone (stabilizers and medium eartips installed)



AC charger

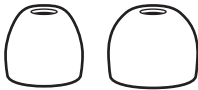

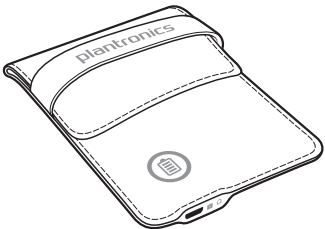

Eartips (small and large)



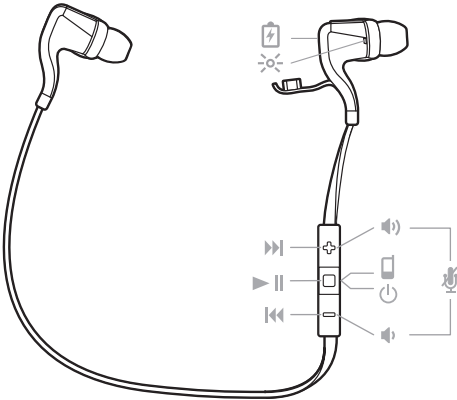

Charge case

Headset overview





-
-  Charge port

 -  Headset indicator light (LED)

 -  Volume up button: Increases volume, skips to next track

 -  Audio/call button: Powers on/off earbuds, answers/ends/declines call, plays/pauses music

 -  Volume down button: Decreases volume, plays previous track

 -  Mute/Unmute
-

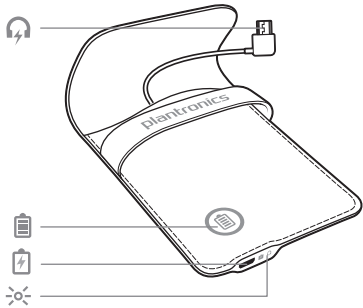

Charge case overview



-
-  Micro USB plug

 -  Press for charge case battery level

 -  Micro USB charge port

 -  Charge case indicator lights;  indicates charge case battery level and  indicates charge state of earbuds
-

Pair

Get Paired

The first time you power on your earbuds, it begins the pairing process.

- 1 Power on the earbuds. The indicator light, located on the right earbud, flashes red and blue to indicate pairing mode.

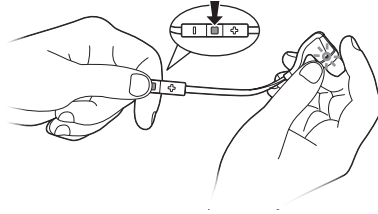

- 2 Activate Bluetooth® on your phone and set it to search for new devices.
 - **iPhone*** Settings > General > Bluetooth > On
 - **Android™ Smartphones*** Settings > Wireless & Networks > Bluetooth: On > Scan for devices

NOTE * Menus may vary by device.

- 3 Select "PLT_BBTGO2."
If necessary, enter four zeros (0000) for the passcode or accept the connection.

Once successfully paired, you hear "pairing successful" and the earbud indicator light stops flashing.

NOTE To enter pairing mode after the first pairing process, start with the earbuds powered off and then press and hold the Audio/call button until you hear "pairing."

Pair another device

After pairing your earbuds to your phone, you may want to pair another phone or device, such as a tablet. You can pair and remember up to eight devices, supporting Handsfree and Advanced Audio Distribution (A2DP) profiles.

- 1 Put the earbuds in pairing mode. Choose:
 - With the earbuds powered off, press and hold the Audio/call button  until you hear "pairing" or
 - With the earbuds powered on and not during a call, press and hold the volume up (+) and volume down (-) buttons until you hear "pairing"

The indicator light , on the right earbud, flashes red and blue to indicate pairing mode.

- 2 Activate Bluetooth on your phone and set it to search for new devices.
- 3 Select "PLT_BBTGO2."
If necessary, enter four zeros (0000) for the passcode or accept the connection.

Once successfully paired, you hear "pairing successful" and the headset indicator lights stop flashing.

Multi-connectivity

When you have more than one device paired to your earbuds, multi-connectivity allows you to toggle the connection between the devices from the Bluetooth device list of your phone/music device (The earbuds can only be connected to one device at a time.).

For example, if you are connected to a tablet and are finished listening to music and want to switch to one of your other paired phone/music devices, then do the following:

- 1 Go to the paired device list in your Bluetooth settings menu on your phone.
- 2 Select "PLT_BBTGO2."

After, the earbuds accept the new connection, there is no need to delete and re-pair your devices each time; they are remembered and ready to connect anytime when in range.

Charge

Your new earbuds have enough power to pair and make a few calls. To access the charging port, insert your fingernail into the groove on top of the right earbud and pull down.

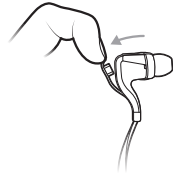

It takes up to 2.5 hours to fully charge the earbuds. While charging, the indicator light is red and turns blue once charging is complete.

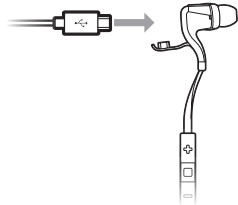

Check battery level

You can check the battery level by tapping either of the Volume buttons when the headset is idle. Your earbuds announce battery status and the indicator light flashes to show the charge level.

"Battery level high" = battery OK to fully charged

"Battery level low" = less than 1 hour remaining

"Recharge headset" = under 15 minutes remaining

Blue flash = battery OK to fully charged

Double red flash = battery low, less than 1 hour remaining

Triple red flash = under 15 minutes remaining

Use charge case

With a fully charged case, charge your earbuds for 20 minutes to add up to an hour of power. Charge the earbuds for 2.5 hours for a full charge.

You can check charge case battery level by pressing the Battery status button .

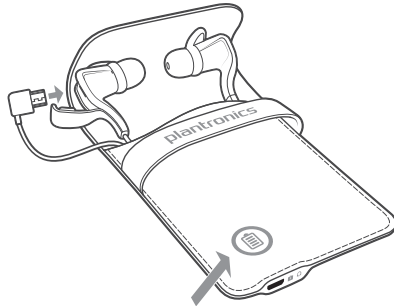

Charge case indicator light

-
-  Battery high

 -  Battery medium

 -  Battery low

 -  Battery critical

Earbud indicator light

-
-  Flashes white every 10 seconds to indicate charging; stops flashing when fully charged
-

Fit

Selecting the right size eartip is essential for you to fully appreciate the premium audio quality the earbuds offer.

- 1 **Acoustic seal** Out of the box, the medium eartips are installed on the earbuds. We recommend that you try each eartip (small, medium and large), perform a sound check and choose the eartip that gives the best sound experience. A snug fit will ensure a rich bass response.



- 2 **Comfort and stability** The stabilizers can be rotated to three pre-set positions. Rotate the stabilizer to adjust the angle to achieve optimal fit and stability.

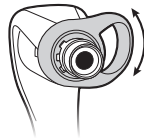

- 3 Drape the earbuds around the back of your neck and enjoy.

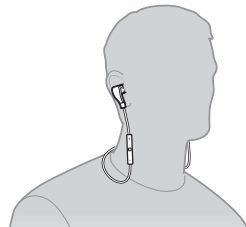

The Basics

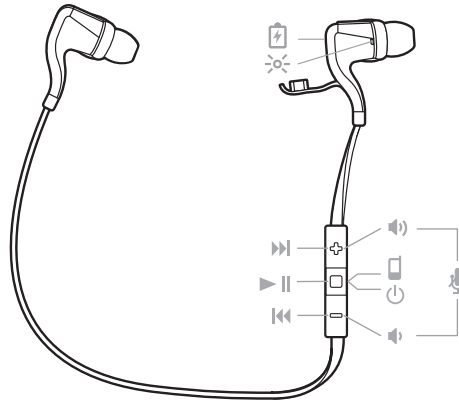

Power the earbuds on or off

Press the Audio/call button ► || / ◻ until you hear "power on." To power off, press the Audio/call button ► || / ◻ for 4 seconds until you hear "power off."

Audio

Play or pause audio

Tap the Audio/call button ► || / ◻.

Skip to next track

Press the Volume up (+) button for more than 1 second.

Play previous track

Press the Volume down (-) button for more than 1 second to restart the current track. Press the button twice (each press more than 1 second) to go to the previous track.

Adjust the volume

Tap the Volume up (+) or down (-) button.

Mute

During a conversation, simultaneously tap the Volume (+) and (-) buttons. You will hear "mute on" or "mute off." An alert repeats every 5 minutes when mute is on.

Make/Take/End Calls

You will hear an incoming call alert while listening to audio. When you take the call, your stored audio (downloaded tunes, video or podcasts) will pause. If you are listening to live streaming audio then it will mute, not pause, during your call. Once you end your call, your playback or streaming will resume.

Answer or end a call

Tap the Audio/call button ► || / ◻.

Use call waiting

First, tap the ► || / ◻ button to put the first call on hold and answer the second call. To switch between calls, press the Audio/call button ► || / ◻ for 2 seconds. To end the second call and retrieve the first call, tap the Audio/call button ► || / ◻.

Decline a call

Press the Audio/call button ► || / ◻ for 2 seconds.

Redial

Double tap the Audio/call ► || / ☎ button to dial the last number you called.

More Features

Deepsleep Mode

If you leave your headset powered on but out of range of your paired phone for more than 20 minutes, your headset will conserve its battery power by entering into a DeepSleep™ mode.

Once back in range with your phone, press any button to exit DeepSleep mode. If your phone is also ringing, tap the Call button ☎ again to answer your call.

Stay connected

Bluetooth has a working "range" of up to 33 feet between the phone and earbuds before audio degrades and the connection is lost.

Your earbuds try to reconnect after a lost Bluetooth connection. If they can't, then tap the Audio/call button once or manually reconnect via the phone's Bluetooth device menu.

Voice alerts

Your headset speaks English.

Voice alerts list

- "Battery low/medium/high"
- "Connection switched"
- "Headset connected"
- "Not connected"
- "Mute on/off"
- "Pairing"
- "Pairing successful"
- "Power on/off"
- "Recharge headset"
- "Redial"

Restore factory settings

When you restore the earbuds to its factory settings, the paired devices list is deleted.

- 1 First, put the earbuds in pairing mode. Choose from the following:
 - With the earbuds powered off, press and hold the Audio/call button until you hear "pairing" or
 - With the earbuds powered on and not during a call, press and hold the volume up (+) and volume down (–) buttons until you hear "pairing"

The indicator light, on the right earbud, flashes red and blue to indicate pairing mode.

- 2 Second, while the earbuds are in pairing mode, press and hold the volume up (+) and volume down (–) buttons until the LED flashes purple.
After the reset, the earbuds power off.

Specifications

Talk/Listening time	Up to 4.5 hours listen/5 hours talk*
Standby time	Up to 10 days*
DeepSleep technology	Provides up to 180 days* of battery readiness
Operating distance (range)	Up to 33 feet from phone or tablet
Headphones weight	14 grams
Audio	HQ custom SBC codec, 6mm neodymium speakers, Frequency response 20-20,000 Hz, Total Harmonic Distortion <5%, sensitivity 104 dBspl/mW @ 1 kHz
Noise reduction	Digital Signal Processing (DSP) : <ul style="list-style-type: none">• Full duplex echo cancellation• Real time noise reduction• Voice clarity
Moisture protection	P2i nano-coating for sweat and moisture protection
Charge connector	Micro USB charging
Battery type	Rechargeable, non-replaceable lithium-ion polymer
Charge time (maximum)	2.5 hours (Power requirements 5V DC - 180 mA)
Bluetooth 2.1 + EDR	Advanced Audio Distribution Profile (A2DP) v1.2, Audio/Video Remote Control Profile (AVRCP) v1.4, Handsfree Profile (HFP) v1.5 and Headset Profile (HSP) v1.1
Operating and storage temperature	32°F – 104°F (0 – 40°C)

NOTE * Performance is dependent upon battery and usage and may vary by device.

NEED MORE HELP?

plantronics.com/support

plantronics[®]
Simply Smarter Communications™

Plantronics, Inc.

345 Encinal Street
Santa Cruz, CA 95060
United States

Plantronics BV

South Point Building C
Scorpius 140
2132 LR Hoofddorp, Netherlands

© 2013 Plantronics, Inc. All Rights Reserved. Bluetooth is a registered trademark of Bluetooth SIG, Inc. and any use by Plantronics is under license. All other trademarks are the property of their respective owners.

US Patents Pending

201075-06 (08.13)

plantronics[®]

