

Elara 60 WS with Voyager Focus

User Guide

Contents

Set up and power	3
Pair	4
Pair your phone	4
Pair your headset to the base	4
OPTIONAL Dual pair your headset	4
Charge	5
Charge your phone	5
Charge your headset	5
Basics	6
Headset and base controls	6
Power on your headset	6
Make, answer, end calls	6
Volume	7
Connect/Disconnect	7
Switch audio	7
Switch users	7
Stream media	7
Change base language, date and time	7
Use Microsoft Teams	7
Video conference	7
Base menu and settings	9
About the base menu and softkeys	9
Navigate the base menu	9
Change settings	9
Headset Features	10
Wear on the right or left	10
ANC	10
OpenMic	10
Use sensors	10
DeepSleep Mode	10
Troubleshooting	12
Support	13

Set up and power

- 1 Using the illustration, set up the mobile phone station. Ensure the power cord is not under the foot of the base.

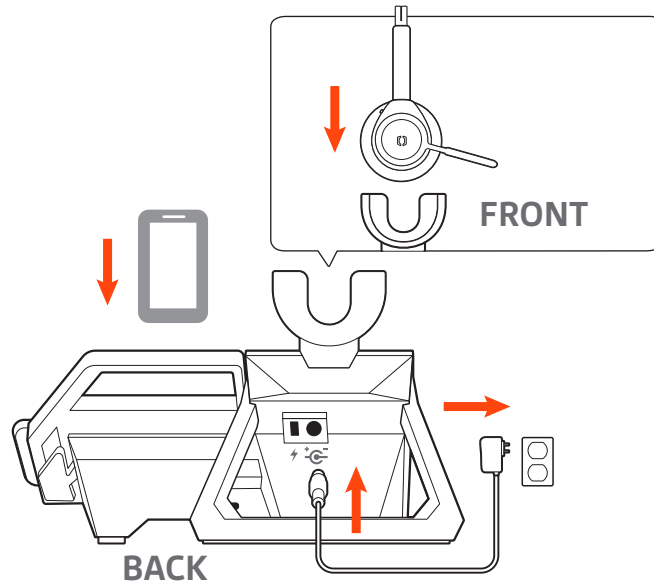

- 2 Next, slide the switch on your headset and power it on.



- 3 **OPTIONAL:** Install a Kensington lock (port on the back) for security.

Pair

The mobile phone station comprises three devices: 1) the base 2) the headset 3) your phone. The base and headset are already paired if purchased together. To use the base with your phone, pair your phone to the base.

Pair your phone

The base can pair with up to 8 Bluetooth devices, maintaining 1 active connection.

- 1 To pair your mobile phone to the base, place your phone on the charge pad and press the "Pair" softkey.
NOTE To pair a another Bluetooth device or to pair your phone again, go to *Settings > Bluetooth > Devices > Add New*.
- 2 Go to Bluetooth settings on your mobile phone/Bluetooth device and select **Poly Elara 60 Series**. Follow the on-screen directions to finish pairing.
TIP If you have trouble pairing/connecting, forget prior Elara connections in your device's Bluetooth settings and retry.

Pair your headset to the base

Pairing your headset to the base only needs to be done if your headset and mobile base station were purchased separately or if you need to pair the headset to the base again.

- 1 To pair your headset to the base, use the base softkeys to go to **Settings > Bluetooth > Headset Pairing > Add New**.
- 2 Put your headset in pair mode by pressing and holding the power button towards the Bluetooth icon until you hear "pairing" and the headset LEDs flash red and blue.
- 3 Press **Next** and follow the on-screen instructions.

OPTIONAL Dual pair your headset

OPTIONAL If you want to continue a call or streaming audio on your headset away from the range of the base, you can also pair your phone to the headset.

- 1 Press and hold the headset Power button towards the Bluetooth icon until you hear "pairing" and the headset LEDs flash red and blue.

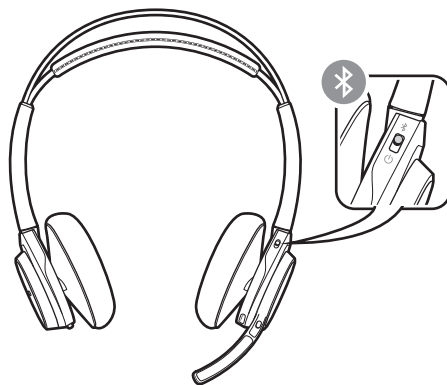

- 2 Go to Bluetooth settings on your mobile phone and select **PLT Focus**. Once successfully paired, you hear "pairing successful" and the LEDs stop flashing.
- 3 Use your phone's menu to switch the audio from the base to the headset if you want to walk away from the base and keep using your headset.

Charge

Charge your phone

The wireless charger is designed to support mobile phone wireless charging (landscape or portrait mode).

Wireless charging: If your mobile phone supports wireless charging, align the phone (vertically or horizontally) to the left edge of the charge pad.

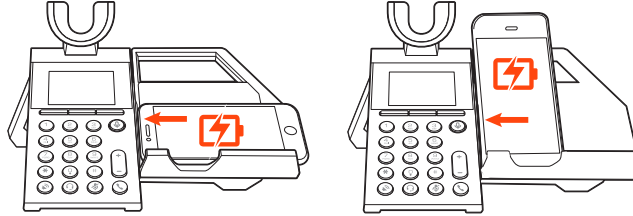

Wired charging: For wired charging, connect a charge cable (not provided) as shown. Connection provides power only.

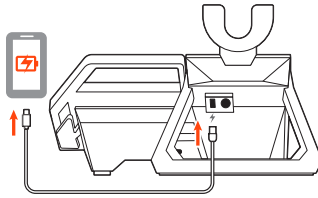

Charge your headset

Charge your headset by placing it in the base cradle.

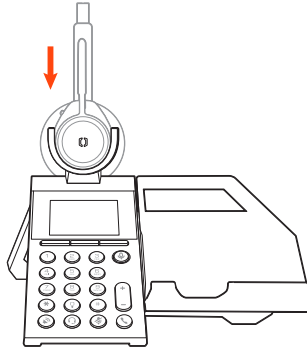

Basics

Headset and base controls

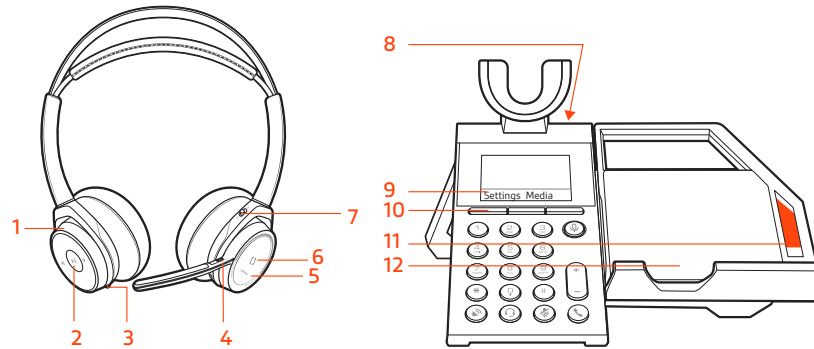

- 1 Volume wheel** Rotate volume wheel to adjust volume
- 2 Play/pause music, track forward/backward** Press to play music
- 3 ANC (Active Noise Canceling)** Toggle on/off
- 4 Mute (active call) and Open Mic (idle) button** During a call, press to mute/unmute. When not on a call, press Open Mic on/off
- 5 Headset LEDs** Flash when in use
- 6 Call button** Press to answer/end a call
- 7 Power and Bluetooth button** Toggle power on/off; press towards Bluetooth icon for pairing
- 8 Charge port** USB charge port for wired charging
- 9 Softkey labels** Text above a softkey, indicating function
- 10 Softkeys** Keys below the base display that have variable function
- 11 Platform release lever** Releases the platform from a vertical position
- 12 Wireless charge platform** Requires phone that supports wireless charging

Power on your headset

To turn on the headset, slide the Power button on the bottom of the earcup to reveal green.

Make, answer, end calls

Make a call

To make a call, dial a number from your phone or the base and press the Call  button.

NOTE After you have dialed a number, use the "Line" softkey to toggle between a cell call and Microsoft Teams call (requires active Teams connection).

Answer a call



To answer a call, do one of the following:

- put on the headset (headsets with sensors only)
- press the Call  button on the base or headset
- press the "Accept" softkey

End a call

To end a call, press the Call  button on the base, phone or headset or press the "End call" softkey.

Redial

To redial the last outgoing call, tap the base Call  button or double press the headset Call  button.

Volume

Press the +/- buttons on the base or rotate the volume wheel  forward (+) or backward (-) on the headset to control the volume.



Connect/Disconnect

Connect: If your phone is paired to the base and you walk out of range of the base with your phone, then the base disconnects from your phone. To connect again when you come back in range, press the "Connect" softkey.

NOTE *If more than one phone is paired to the base, a "Device" softkey appears instead to offer the ability to choose which phone to connect.*

Disconnect: If you would like to disconnect the Bluetooth connection between the base and your phone, press the "Disconnect" softkey.

Switch audio

To switch audio to the speakerphone  or headset , press the corresponding button on the base.

Switch users

If the base is shared, pair your phone to the base (it can pair up to 8 devices with 1 active connection) and switch between phones by pressing the "Device" softkey and selecting your phone.

Stream media

To stream media, open the app on your phone and select the "Media" softkey on the base.

Change base language, date and time

Automatic language, time and date synchronization is triggered by opening the Poly Elara or Microsoft Teams app on your phone.

Use Microsoft Teams

Download and open the Microsoft Teams app on your phone. Press the dial pad Teams button to launch.

TIP *First use on Android, launch the Teams app and then disconnect and reconnect Bluetooth to initiate.*

The base Microsoft Teams button pulses when various notifications are available (missed calls, voice mails, etc). Customize how Microsoft teams interacts with the base by going to Settings > Microsoft Teams.

Video conference

- 1 Tilt the charge platform for a better video conference experience.

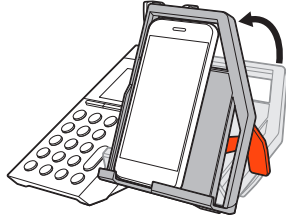

- 2 To release the charge platform, pull the orange lever forward.

Base menu and settings

About the base menu and softkeys

Use the base menu to adjust and customize settings.

- **Settings > General:** Change display brightness, headset sensor settings, time and date; restore factory defaults; restart station
- **Settings > Bluetooth:** Pair devices to the base; switch between paired devices
- **Settings > Microsoft Teams:** Adjust how the base interacts with Microsoft Teams
- **Media:** Plays music from your phone

Navigate the base menu

Use the base keys and softkeys to navigate the base menu.

- **Settings menu navigation** Use the softkey arrows or the volume up/down buttons to navigate between choices in the base menu.
- **Return home:** Press the base Call  button to return to the home screen when navigating through the base display.

Change settings

Settings can be changed from the base menu and the Poly Elara app (available at the Apple App Store or Google Play Store).

	Elara base menu	Poly Elara app
Change language	X*	
Adjust headset sensor settings	X	X
Set time, date, language	X**	X**
Update firmware		X
Microsoft Teams settings	X	X
Media player settings	X	X
View user guide		X

*To change your headset language or settings, download *Plantronics Hub* [here](#).

**Automatic language/time/date sync is triggered by opening the Poly Elara app on your phone. Opening the app overrides any base menu settings.

Headset Features

Wear on the right or left

To position the microphone on the right or left side, rotate the microphone boom up and over. Adjust the boom so it points to the corner of your mouth.

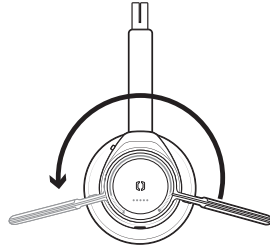

TIP Your headset senses when you change the microphone boom from one side to the other and syncs the audio and controls specific to each side.

ANC

Active Noise Canceling (ANC) reduces external noise and enhances your music and sound quality.

Your headset ships with ANC on. To turn ANC off, slide the switch away from "ANC."

OpenMic

While not on a call, tap the red Mute button to activate OpenMic and hear your surroundings. Control the level of ambient noise you hear by adjusting the volume wheel.

Use sensors

Smart sensors respond when you put on or take off your headphones.



With active sensors	putting on the headset will:	taking off the headset will:
Call	answer the call	mute the headset
Music/media	resume music/media (if playing previous to taking off)*	pause music/media (if playing)*
Mute	unmute if on an active call	mute if on an active call

NOTE *Functionality varies by application. Does not function with web-based apps.

Reset sensors



You may need to reset the sensors if they are not working as expected.

There are two ways to reset the headset sensors. Choose:

- With your headset powered on, charge your headset on the charge stand for 10 seconds
- Press and hold both the Mute  and Play/pause  buttons for more than 4 seconds until the LEDs flash purple twice, being careful to not touch the earcup padding or allow it to come in contact with surfaces

Disable sensors

You can disable your headset smart sensors several ways:

- Manage sensors through Plantronics Hub software
- Hold both the Mute  and Call  buttons for more than 4 seconds until the LED flashes purple then red. Repeat to reactivate; the LED flashes purple then blue

NOTE Sensors cannot be disabled while streaming audio.

DeepSleep Mode

If you leave your headphones powered on but out of range of your paired phone or USB adapter for more than 7 days, your headset conserves its battery power by entering into DeepSleep mode.

Once back in range with your phone or USB adapter, press the Call control  button to exit DeepSleep mode.

Troubleshooting

In the event of an electrostatic event	The wireless charger resets within 45 seconds.
When I use the media player with Elara and YouTube, the media player freezes.	This is a known issue for iOS phones.
Known issues with iPhone 5s	<ul style="list-style-type: none">• When an iPhone 5s is paired to Elara, with two calls, both are terminated when the call button is pushed• Calls cannot be swapped with iPhone 5s• Conference calls that include an iPhone 5s require the call to be ended on the iPhone

Support

NEED MORE HELP?

plantronics.com/support

Plantronics, Inc.

345 Encinal Street
Santa Cruz, CA 95060
United States

Plantronics B.V.

Scorpius 171
2132 LR Hoofddorp
Netherlands

© 2019 Plantronics, Inc. All rights reserved. Poly, the propeller design, and the Poly logo are trademarks of Plantronics, Inc. Bluetooth is a registered trademark of Bluetooth SIG, Inc. and any use by Plantronics, Inc. is under license. All other trademarks are the property of their respective owners.

215338-06 09.19