

Savi 410/420

Wireless headset system

User Guide

Welcome

Congratulations on purchasing your new Plantronics product. This user guide contains instructions for setting up and using your Savi W410/W420 (D100 USB Adapter + WH300/350 Headset) Wireless Headset System.

Please refer to the separate [safety instructions](#) for important product safety information prior to installation or use of the product.

DECT INFORMATION

Plantronics is a member of the DECT Forum and has fully adopted their recommendations for enhancements to security within all DECT products.

Plantronics DECT-based products now fully incorporate the latest recommendations for Enhanced Security from the DECT Forum and ETSI. These improvements cover registration, authentication, authorization and encryption procedures. Plantronics DECT products are now secure against all the known vulnerabilities that were highlighted by the public announcements of the Chaos Council in 2009.

Plantronics Savi 400 Series DECT products have been tested against and passed the DECT Forum security certification requirements and consequently have been granted 'DECT Forum security' logo certification. Plantronics products using the new enhanced version of DECT that includes these security improvements are marked on the base with the DECT Forum security logo.



The enclosed DECT 6.0 wireless product uses restricted wireless radio frequencies which vary by country. DECT 6.0 devices are generally authorized for use in The Americas. Use of this DECT 6.0 product in unauthorized countries is a violation of law, may disrupt telecommunications networks and devices, and can subject you to fines and penalties by regulatory agencies. For specific countries in which DECT 6.0 devices may be lawfully used, please consult: <http://www.dect.org>

Contents

| | |
|--|----|
| 1 Package Contents..... | 4 |
| 2 System Features..... | 5 |
| 3 Headset Setup..... | 6 |
| 3.1 Adjust the Headband..... | 6 |
| 3.2 Adjust the Mouthpiece..... | 6 |
| Assembling Base | 6 |
| 4 System Setup..... | 7 |
| Connecting the Power Supply..... | 7 |
| Docking and Charging the Headset..... | 7 |
| Connecting the USB Adapter to your PC | 7 |
| Loading software | 7 |
| USB Adapter Indicator Light..... | 8 |
| 5 Using Your Headset System..... | 9 |
| Powering Up the Headset..... | 9 |
| Talk Time..... | 9 |
| Muting a Headset During A Call | 9 |
| Placing the Headset in Sleep Mode | 10 |
| Headset Tones | 10 |
| Battery Life Status | 10 |
| Headset Indicator Light | 10 |
| Subscribing a Headset | 10 |
| Ending Subscription | 10 |
| Listening to Other PC Audio..... | 10 |
| 6 Making Calls With your Headset and PC | 11 |
| Software Installation | 11 |
| Making Calls With Your Headset and PC | 11 |
| Auto Answer | 11 |
| Conferencing Up to Three Guest Headsets..... | 12 |
| Conferencing Additional Headsets and Security Levels..... | 12 |
| 7 Advanced Use..... | 13 |
| Install Plantronics Hub..... | 13 |
| Start Hub | 13 |
| Plantronics Hub | 13 |
| Devices Tab | 13 |
| 8 Update Firmware and Software Manager | 18 |
| 9 Troubleshooting and Common Questions..... | 19 |

1 Package Contents

Savi W410/W420 USB Adapter and Charger

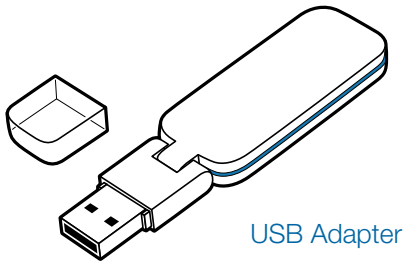

USB Adapter

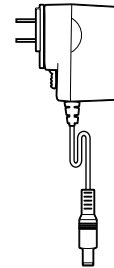

Base Power Supply

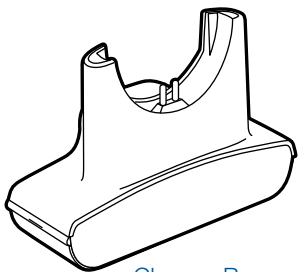

Charger Base

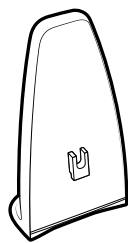

Base Stabilizer

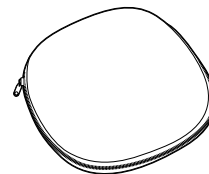

Carrying Case

Savi WH300/350 Headset



Headset

2 System Features

Savi USB Adapter Features

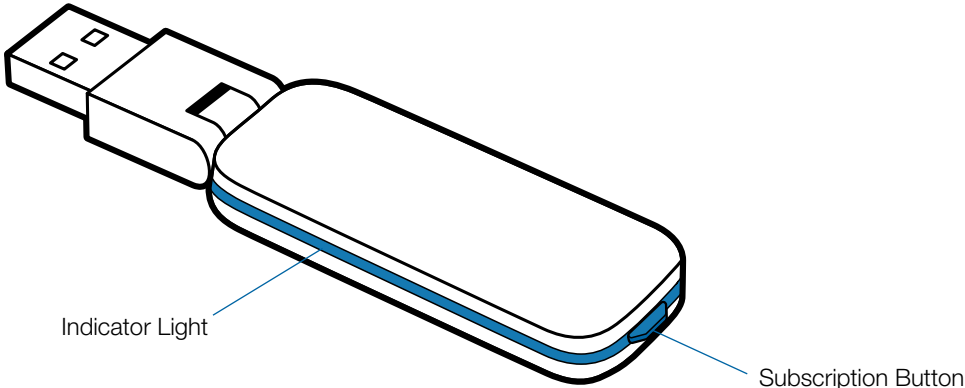

Savi WH300/350 Headset Features

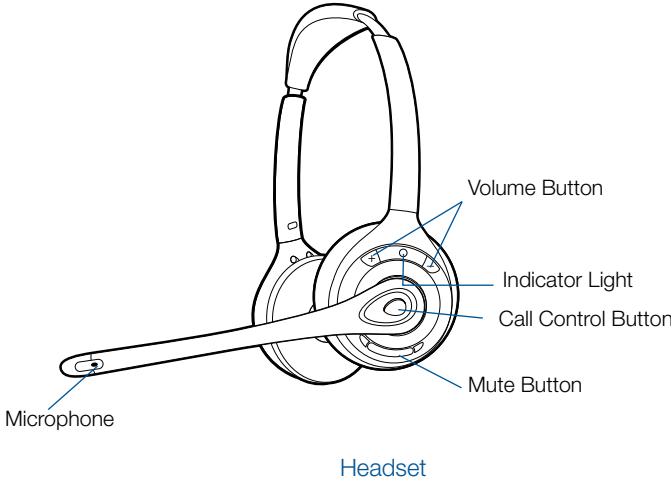

3 Headset Setup

3.1 Adjust the Headband

- 1 To adjust the headband, lengthen or shorten the band until it fits comfortably. Position the headset receivers so that the foam cushions sit comfortably over the center of your ears.**
- 2 On the WH300, position the stabilizer T-bar above your ear.**
- 3 For a tighter fit, gently pull the opposite ends of the headset inward as shown.**

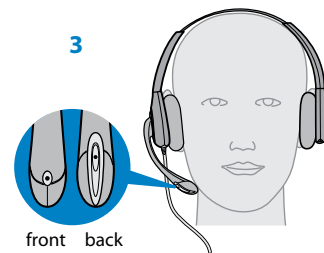
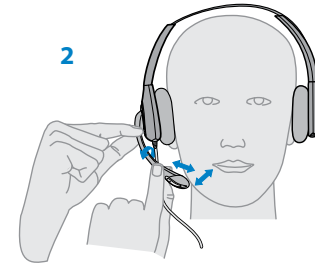
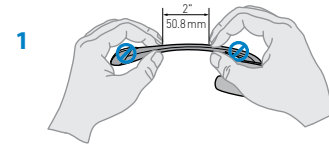
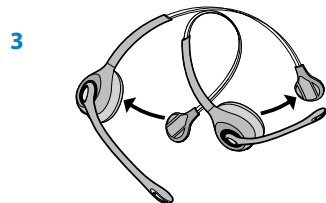
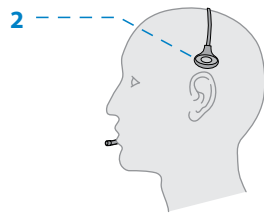

Assembling Base

- 1 Separate the top from the bottom of the charger base.**
- 2 Attach the base stabilizer to the base, then re-attach the top.**

NOTE This product has a replaceable battery. Use only the battery type supplied by Plantronics.

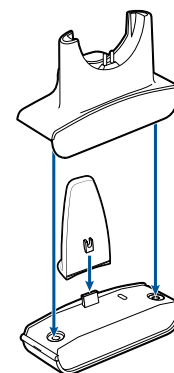

3.2 Adjust the Mouthpiece

- 1 Carefully bend and shape the boom with both hands as shown. Avoid bending or twisting the boom near the microphone or earpiece.**
- 2 Position the click-stop turret and boom so that the microphone is two finger-widths from the corner of your mouth.**
- 3 Make sure the front of the microphone faces your mouth.** If necessary, twist the microphone slightly so it's in the proper position. Do not use forceful twisting motions or try to turn the microphone completely around.

4 System Setup

Connecting the Power Supply

- 1 **Connect the base power supply into the power jack on the charger base.**
- 2 **Connect the power supply to the outlet.** The power indicator light will be solid green.

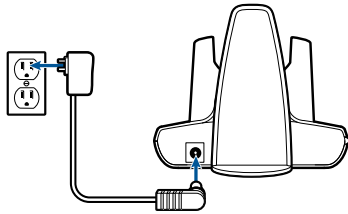

Docking and Charging the Headset

- 1 **Gently push the headset into the charging cradle.**
The charging indicator light on the headset will flash green to indicate that the headset battery is charging.
- 2 **Charge for at least 20 minutes prior to first use.** A full charge takes 4.5 hours.

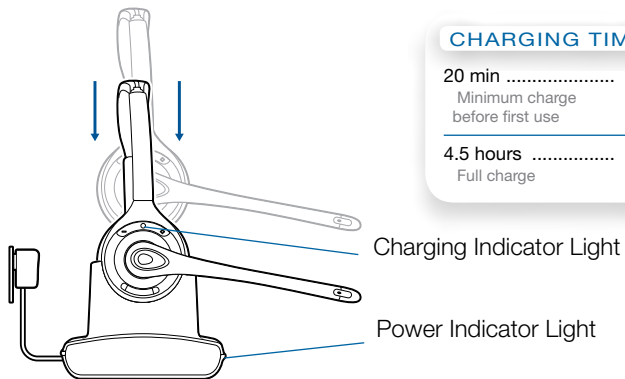

Connecting the USB Adapter to your PC

- 1 **Insert the USB adapter into USB Port on PC.** The indicator light on the USB adapter will be solid red to indicate the USB adapter is powered on and will turn solid green when it connects to the headset.

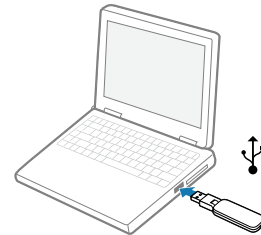

NOTE The headset may have to be charged before the USB adapter can find it.

- 2 **The USB adapter can be folded as shown.**

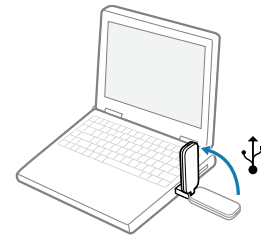

Loading software

- 1 **Load the Plantronic Hub software by visiting plantronics.com/software and click on the download button.**

USB Adapter Indicator Light

| USB Adapter Status | USB Indicator Light |
|---|--------------------------|
| Headset subscribed, no activity | Solid green |
| Headset in talk mode | Flashes green |
| Headset muted | Flashes red |
| Incoming call | Flashes red and yellow |
| Headset not subscribed | Solid red |
| USB adapter subscription | Flashes green and red |
| USB adapter conference subscription | Flashes green and yellow |
| On conference call with one or more guest headsets subscribed | Flashes yellow |

5 Using Your Headset System

Powering Up the Headset

If the headset battery is charged and connected to the headset, the headset is automatically on. The headset does not have an on/off button.

Talk Time

With a single full charge, the Savi W410/W420 will provide up to 13 hours of talk time. Talk time will be reduced when operating in wideband mode and/or if the headset is used consistently at a far distance from the adapter.

Muting a Headset During A Call

Short press the dedicated mute button to toggle mute on/off. The USB adaptor light will flash red when the headset is muted.

When mute is activated, you will hear three high tones. When unmuted, you will hear three low tones.

After the Plantronics software is loaded, the mute tones can be turned off by going to Start > Programs > Plantronics Hub > Settings > Ring Tones & Volume > Mute Reminder Volume.

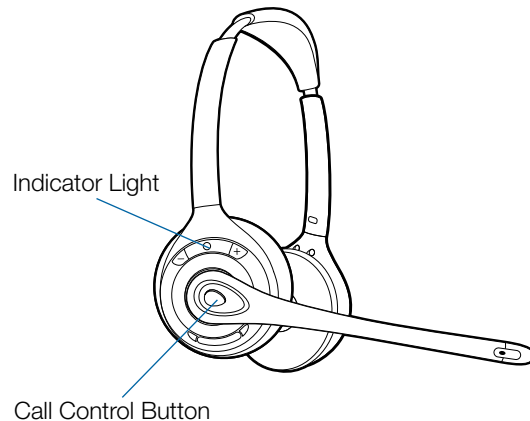

For your safety, do not use headset at high volumes for extended periods of time. Doing so can cause hearing loss. Always listen at moderate levels. For more information on headsets and hearing visit:

plantronics.com/healthandsafety.

Placing, Answering, and Ending Calls with Desk Phone

| | Phones with Handset Lifter or Electronic Hookswitch | Phones without Handset Lifter or Electronic Hookswitch |
|------------------|--|--|
| To place a call | <ol style="list-style-type: none">1. Short press call control button on headset* or short press base desk phone talk button2. Dial number | <ol style="list-style-type: none">1. Short press call control button on headset* or short press base desk phone talk button2. Remove handset from cradle**3. Dial number |
| To answer a call | <ol style="list-style-type: none">1. Short press call control button on headset or short press base desk phone talk button | <ol style="list-style-type: none">1. Short press call control button on headset or short press base desk phone talk button2. Remove handset from cradle** |
| To end a call | <ol style="list-style-type: none">1. Short press call control button on headset or short press base desk phone talk button | <ol style="list-style-type: none">1. Short press call control button on headset or short press base desk phone talk button2. Return handset to cradle** |

*Assumes use of supported softphone

**Assumes your default line is set to PC

Placing the Headset in Sleep Mode

If you won't be using the headset for a long period of time and the headset will not be in the charging cradle, you can put the headset in sleep mode. With the headset idle, press the call control button for three seconds until you see the headset flash white twice. To wake the headset, press the call control button again and you will see two white flashes.

Headset Tones

Out of range warning

If you are on a call and go out of the operating range, you will hear three low tones. You will hear a single mid tone when you are back in range.

If you stay out of range, active calls will be suspended. Calls will be re-established when you walk back into range. If you remain out of range for more than 5 minutes, the system will drop the call.

If you are not on a call and go out of the operating range and press the call control button, you will hear a single tone for the button press and three low tones for the failure to make a link.

Low battery warning

If you are on a call, you will hear a repeated single low tone every 15 seconds indicating that the battery is low. You should recharge the headset immediately.

If you are not on a call and press the call control button, you will hear three low tones indicating that the battery is low. You should recharge the headset immediately.

Battery Life Status

At the lower right corner of your screen in your system tray, your headset battery status will be indicated with one of the following icons:

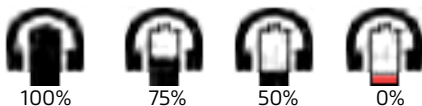

NOTE Plantronics Hub Software must be installed for system tray icon. (See next section)

A warning will be issued if your headset is critically low.

Headset Indicator Light

If you are not on a call, you can toggle the headset in-use

indicator light on and off by pressing the headset volume down button for three seconds.

Subscribing a Headset

The headset and USB adapter that are supplied together are already subscribed to each other. However, if you wish to use a new headset with your existing USB adapter or you need to restore subscription to your current headset, the units can be subscribed to each other by the following method:

- 1 Ensure your headset is charged.**
- 2 Double press the subscription button on the USB adapter.** The USB adapter will flash red and green.
- 3 Press the volume up button on the headset for three seconds until the headset indicator light turns solid green.**
- 4 When the indicator light on the USB adapter goes solid green, the headset and the USB adapter are subscribed to one another.**

To ensure subscription was successful, press the call control button: the headset will flash white and the USB adapter will flash green.

NOTE If the subscription process times out after two minutes or if the subscription process fails, the USB adapter indicator light will become solid red for four seconds and then return to its previous state. If this occurs, try to re-subscribe the headset again.

Ending Subscription

If the USB adapter is in subscription mode and you want to stop the adapter from searching for a headset, press the subscription button again. The subscription light will turn solid red for four seconds and then go to its previous state.

Listening to Other PC Audio

Ensure the PC audio you are trying to listen to is being routed to your Savi 400 device.

- 1 Go to “Windows” and open “Sound”.**
- 2 Select your Savi 400 device under “Sound Playback”.**
- 3 Launch the application that contains the PC audio and hit play.**

6 Making Calls With your Headset and PC

Software Installation

It is highly recommended that you install the Plantronics software. Though your Savi system will operate without the software, it will limit the system's full capabilities.

Install the Plantronics Hub software to enable remote call answer/end with compatible softphones. The software can be downloaded at plantronics.com/software.

After installation, to visit the Plantronics control panel, click on Start > Plantronics > Plantronics Hub.

Plantronics Hub for Windows software runs on the Intel x86 and x64 platform (including compatible CPUs from other manufacturers) running Windows 8, 7, Vista SP2 and XP SP3 (x86 only) (Basic, Professional and Enterprise Editions).

Making Calls With Your Headset and PC

| | With Plantronics Software and a Compatible Softphone | Without Plantronics Software |
|------------------|--|--|
| To place a call | Dial number from a compatible softphone application | 1. Short press call control button on headset 2. Dial number from softphone application |
| To answer a call | Short press call control button on headset | 1. Short press call control button on headset 2. Answer call using softphone application |
| To end a call | Short press call control button on headset | 1. Short press call control button on headset 2. Hang up call using softphone application |

Softphone Support

Remote call answer/end from the Savi headset is available for all softphones with no additional steps by the user except Skype for consumer. For a list of compatible softphones visit plantronics.com/software.

For Skype consumer version, you will receive a pop up the first time you use Savi 400 asking if you wish to use D100 (Savi 400 dongle) with Skype. Select "ok" to accept.

Auto Answer

Auto answer saves the user a button press to establish the radio link between headset and adapter.

The Savi W410/W420 is supplied with auto answer NOT SELECTED as the default. When auto answer is set to NOT SELECTED you must press the headset call control button to answer an incoming call. When Auto Answer is set to SELECTED an incoming call will be answered when the headset is removed from the charge cradle.

To change the setting, go to: Start > Programs > Plantronics > Plantronics Control Panel > Device Settings – USB adapter.

Conferencing Up to Three Guest Headsets

While on a call, you can subscribe up to three guest headsets to your USB adapter for conferencing. As you add headsets to the adapter, you can see the number of Conferenced headsets in the Plantronics Hub “About” tab under “Connections.”

Guests may conference in as described below:

- 1 While you are on a call, place the guest’s headset into subscription mode.
- 2 Short press (less than one second) the subscription button on the USB adapter. The USB adapter light will flash yellow and green.
- 3 The USB adapter light will then turn solid yellow and you will hear a tone in the master headset indicating a guest wishes to join the call.
- 4 If you press the call control button on the master headset within five seconds, the guest is joined to the call.

If you do not press the call control button within five seconds, the request to join the call is rejected and the guest will hear an error tone in their headset.

- 5 Guests may leave the conference call by pressing their call control button.

When they do you will hear a single tone in the master headset as each guest leaves the call.

Conferencing Additional Headsets and Security Levels

Your Savi 400 Series headset system (v28 or later) supports DECT Forum recommendations for Enhanced Security. Products with Enhanced Security are marked with the DECT Forum security logo on the base.

Both your headset and USB adapter are compatible with older (prior to v28) headset bases and headsets supporting older versions of DECT. Below is helpful information if you plan to use Enhanced Security and older DECT components together.

If your Enhanced Security headset or USB adapter is conferenced with an older headset or headset base the resulting security level for the mixed headset and base combination will be set to the level of the older version of DECT for all calls. This is because older system components are not able to support Enhanced Security.

All subscription details above apply when conferencing an Enhanced Security headset to an older USB adapter, or visa versa, however there are unique system alerts indicating that the system is changing the security level from Enhanced Security to the older version of security.

If an older headset is subscribed to an Enhanced Security USB adapter:

- The subscription LED (on USB adapter) will flash GREEN 3 times followed by YELLOW 2 times. This tflash pattern repeats 2 times.

If an Enhanced Security headset is subscribed to an older USB adapter:

- The Enhanced Security headset will play a security notification **tone**.
- The mono-colored LED on the headset will flash 3 times, then 2 times. This flash pattern is repeated 2 times.

7 Advanced Use

Plantronics Hub resides on your computer system and allows you to customize your settings and get visible status of your Plantronics audio device on your desktop. Plantronics Hub provides users with an easy way to change device and software settings and install software and firmware updates.

This section provides information specific to Savi 400 Series products, with an emphasis on covering all of the available settings for your Savi 400 headset system.

Plantronics Hub has its own comprehensive Plantronics Hub User Guide which can be found: www.plantronics.com/us/product/plantronics-hub-desktop/#support .

Install Plantronics Hub

To access the Plantronics Hub, load Plantronics software by visiting plantronics.com/us/support/software-downloads/ and click on the appropriate download icon.

Start Hub

To start Hub, click Start > Programs > Plantronics > Hub

Plantronics Hub

When you first start Plantronics Hub the About Tab will be displayed. If you have at least one Plantronics device connected to your computer using a USB connector you will see an image of your device along with information about that device. You will also see tabs across the top of the application that read "About", "Updates", "Settings", and "Help" which are described below.

Devices Tab

To configure your settings, select Plantronics D100-M from the pull down menu and click the Device Settings box. Below are the setting options and defaults for the USB adapter and headset.

NOTE Some parameters that do not apply to a particular Plantronics device may appear grayed out.

About Tab

Provides information about your connected device or devices; switch between devices or set primary device (pull down menu, upper left, appears when multiple devices present).

Updates tab

Check for device firmware and Hub software updates; get information about updates when available, install as necessary

Settings tab

Configure available settings for your device or devices, Hub software

Help tab

Support, contact, and troubleshooting information and resources

Hub Settings Options

| | Feature | Settings | Default |
|---------------------------|--|---|-------------------------|
| General (software) | Maintain Headset to PC Radio Link | Active Only During Call/ Always Active | Active Only During Call |
| | Software Log Level Detail | Low/Med/High/Verbose | Low |
| | Metrics Collection to Help Improve Hub | Off/On | On |
| General (Savi 400 Series) | Auto Answer | Off/On | Off |
| | Audio Sensing | Off/On | Off |
| | Second Inbound Call | Ring Continuously/Ring Once/Ignore | Ring Continuously |

Maintain Headset to PC Link

This feature forces the radio link to the PC to stay active even after the call has ended. This can eliminate the need to re-establish the radio link when switching between PC audio applications.

Software Log Level Detail

Adjust the level of detail captured in log files.

Metrics Collection to Help Improve Hub

When selected, this will allow Plantronics to collect data on feature usage pattern. This information will only be used by Plantronics to improve the quality of our future software and hardware products.

Auto Answer

When enabled, this feature will configure your headset to automatically answer a call when it is removed from the charge cradle.

Audio Sensing

Audio Sensing is a special feature supported by Plantronics wireless devices that can detect an audio signal at the USB port and automatically establish the radio link between the base and the wireless headset without the user having to press the call control button. When the Configure Lync Dial Tone parameter is set to On, every time the user presses the call control button, the Lync dial tone will be heard (assuming the user wants to make a softphone call). However, the user may have pressed the call control button to listen to PC music, etc., and does not want to hear the dial tone. In this case, if the user sets the Audio Sensing parameter to On, the radio link will be established automatically when any PC audio is detected at the USB port, thus eliminating the need for the user to press the call control button.

Second Inbound Call

When you are on a call and a second call comes in, this feature enables you to control the ring behavior for the second call. The options are for the call to Ring Continuously until answered (default), for the call to Ring Once and then be silent until answered, or for the call to be ignored completely if Ignore Ring is selected.

Ring Tones and Volumes

| Feature | Settings | Default |
|--|---|--------------------------|
| PC ringtone | Tone 1/Tone 2/Tone 3 Default/Low/Off | Tone 2 Default Volume |
| Mute Reminder Volume | Default Volume/Low Volume/Off | Off |
| System tone | Default/Low/Off | Default volume |
| Wearing Preference for Volume Control | No change/Left ear/Right ear | No change |
| NOTE For Savi 440/445 models only | | |
| Ring location | Headset, Headset/PC | Headset only |

PC Ringtone

Select the ringtone and volume that you hear when your PC softphone rings.

Mute Reminder Volume

Controls the volume of the tone to remind you your microphone is muted, or turn the mute tone off.

System Tone

Sets the volume of your computer's system tones.

Wearing Preference (enabled for Savi 440/445 only)

Volume controls are oriented up/down for right-ear wearing; when switched to left-ear wearing the volume controls will be reversed. This setting allows for the reversal of the up/down volume orientation for left-ear wearing.

Ring Location

This feature gives you the option to have the PC ringtone played on both the headset as well as the PC speaker.

When this feature is selected, the PC ringtone will be heard on both the PC speaker as well as the headset.

When this feature is not selected, the PC ringtone will only be heard on either the headset or the PC speaker based on how the PC audio has been set up.

Softphones and Media Players

| Feature | Settings | Default |
|--------------------------------------|---------------------|--|
| Dial Tone | Off/On | Off |
| Media Player Action on Incoming Call | Pause and Resume/No | Pause and Resume |
| Softphones and Media Player | Enable/Disable | Enable* *for installed softphones and media players |

Dial Tone

Hear a dial tone when you press your headset's call button. Your target softphone must support dial tone.

Media Player Action on Incoming Call

Defines action for your media player when listening to media and an incoming call is received.

Softphones and Media Players

Defines which media players are enabled for Hub interoperability. Avaya one-X Communicator, Avaya one-X Agent, Avaya IP Softphone, Avaya IP Agent, Cisco IP Communicator, Cisco UC Clients (CSF), NEC SP350, Cisco WebEx. Winamp, Windows Media Player, iTunes.

Presence

| Feature | Settings | Default |
|-------------------------------------|----------|---------|
| Aware for Lync & Skype for Business | Off/On | Off |

Auto Update my Presence for Skype for Business/Lync/OC

Update your Skype for Business/Lync/OC presence status when you are on a phone call with your mobile phone, deskphone, or Plantronics supported softphone. Plantronics plugin for Lync must also be installed for this feature to work.

Wireless

| Feature | Settings | Default |
|--------------------|---------------------|------------|
| Range | Low/Med/High | High |
| PC audio Bandwidth | Narrowband/Wideband | Narrowband |

Advanced

Range

Changing the range can help with desk phone/PC audio quality, improve user density or restrict range of users. To change the range with the base see Setting the Range.

| Setting | Range |
|---------|---------------|
| High | up to 350 ft. |
| Medium | up to 150 ft. |
| Low | up to 50 ft. |

PC Audio Bandwidth

Wideband audio delivers heightened speech clarity and life-like fidelity, but consumes more battery power, resulting in reduced talk time.

| Feature | Settings | Default |
|-------------------------------------|---------------|---------|
| Anti-Startle (G616) | Off/On | Off |
| Anti-Startle (Plantronics Enhanced) | Off/On | Off |
| Daily Noise Exposure Limiting | Off/80dB/85dB | Off |

Anti-Startle (G616)

G616 Acoustic Limiting provides additional hearing protection against acoustic shock. When G616 Acoustic Limiting is SELECTED, the system provides additional acoustic shock protection. Sound levels are limited to 102 dBA as recommended in the G616: 2006 guideline issued by the Australian Communications Industry Forum (ACIF). When G616 Audio-Limiting is NOT SELECTED, the headset limits sound levels at 118 dBA to protect your hearing.

Anti-Startle (Plantronics Enhanced)

Plantronics enhanced anti-startle goes beyond G616, and provides advanced hearing protection against sudden loud sounds. When Anti-Startle is SELECTED, the system identifies and eliminates sudden loud sounds and rapidly reduces them to a comfortable level. When Anti-startle is NOT SELECTED, the headset limits sound levels at 118 dBA to protect your hearing.

Daily Noise Exposure Limiting

Daily noise exposure limiting provides advanced hearing protection for daily noise exposure. When Audio-Limiting is SELECTED, the system monitors and controls sound to ensure audio levels do not exceed 80 dBA or 85 dBA (whichever is selected) specified by current and imminent EU legislation. When Audio-Limiting is set to NOT SELECTED, the headset limits sound levels at 118 dBA to protect your hearing.

Updates

On the “updates” tab click “check for updates” to determine if any new updates are available for system firmware or Hub software.

8 Update Firmware and Software Manager

All required software for Savi W440-M can be remotely updated when updates are available. From time to time, updates will be available for the firmware in your headset and for Plantronics Hub software. When an update is available, there will be a number in the Updates tab. Click the Updates tab to see the available updates. When there is an update, it will display in a list on that page. Click “Update” for each update that you want to install. We recommend installing all the updates to keep your device and software functioning at its best.

9 Troubleshooting and Common Questions

When I dial from my softphone application, nothing happens.

Ensure your headset is charged.

Ensure your headset is subscribed to the USB adapter. See [Subscribing a Headset](#).

Ensure that the Plantronics software is installed. To download, visit plantronics.com/software.

Ensure that you are using a compatible softphone application. For a list of compatible softphones, visit plantronics.com/software.

If the Plantronics software is not installed and you do not have a compatible softphone, you must first press the call control button and then use the softphone interface to place/answer/end calls.

Ensure that the headset is the default sound device. The Plantronics control panel will launch the sound devices control panel by going to Plantronics Control Panel > Preferences > General – Launch Audio Devices Control Panel.

Disconnect and re-connect the USB adapter. It will be solid red until it subscribes to the headset; it will be solid green when successfully subscribed to the headset.

Restart your computer.

Speaking and/or listening volume is too low or too high.

Adjust headset listening volume with volume button.

Adjust listening/speaking volumes in the computer's sound control panel/system preferences.

Adjust listening/speaking volumes in the softphone application.

The sound is distorted or I hear an echo in the headset.

Reduce speaking and/or listening volume on the computer using your softphone application.

Point microphone towards your chin.

If the distortion is still present, lower the volume on the headset.

I can no longer hear any audio through my PC Speakers.

For Windows XP systems

- Refer to the “Audio” tab of the “Sounds and Audio Devices” option in your PC Control Panel.
- Under “Sound Playback”, change the default setting from Savi Office to your PC speakers. Click “OK” to confirm your change.

For Windows Vista systems

- Refer to the “Sound” option in your PC Control Panel.
- Under the “Playback” tab, change the default setting from “Speakers Savi Office” to your PC speakers. Click “OK” to confirm your change.

For Mac OS X

- Choose Apple menu > System Preferences and click Sound.
- Click Output, and then select “Internal Speakers” or your speaker choice.

Talk time performance is significantly degraded even after a full recharge.

The replaceable battery is wearing out. Contact plantronics.com to purchase a new battery. Use only the battery type supplied by Plantronics.

Plantronics, Inc.
345 Encinal Street
Santa Cruz, CA 95060
United States
plantronics.com

Plantronics BV
South Point Building C
Scorpius 140
2132 LR Hoofddorp
Netherlands



For product support contact us at plantronics.com/support or call 1-800-544-4660.

© 2015 Plantronics, Inc. All rights reserved. Plantronics, the logo design, Savi, W430, are trademarks or registered trademarks of Plantronics, Inc. Internet Explorer, Microsoft, Windows, Windows Vista, and Windows XP are either registered trademarks or trademarks of Microsoft Corporation in the United States and/or other countries."DECT SECURITY is the trademark of DECT Forum. The trademark may only be applied to products with the written license of DECT Forum."

Patents: US 7,633,963; 9,008,319; D505,413; D535,285; D538,785; D602,008; CN ZL200630123313.2; ZL200630123314.7; ZL200830005446.9; EM 000873823; 000543798; TW D117333; D117515; and D127400.

89922-06 09.15

plantronics