

# LX1 adapter

User Guide

# Contents

- Overview **3**
- Set up **4**
- Support **5**

# Overview

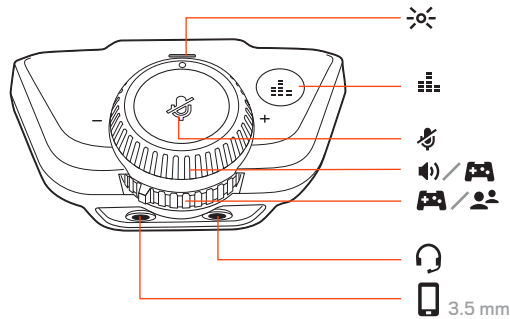

---

 **LED**  
Red = Mute  
Blue = Balanced mode  
Green = Independent mode

---

 **EQ settings (short press)**  
Single tone = Pure EQ maintains high frequencies  
Double tone = Intensify EQ emphasizes mid-range sounds  
Triple tone = Seismic EQ boosts bass  
**Mode settings (press and hold for 4 seconds)**  
Balance mode = The top dial controls master volume and the bottom dial controls game and chat volume  
Independent mode = The top dial controls game volume and the bottom dial controls chat volume

---

 Tap to mute your mic (LED turns red)

---

 **Top dial**  
Balance mode = Controls master volume  
Independent mode = Controls game volume

---

 **Bottom dial**  
Balance mode = Balances game and chat volume  
Independent mode = Controls chat volume

---

 Headset port

---

 3.5mm stereo AUX input

---

**NOTE** Balance mode is the default setting.

# Set up

The adapter is compatible with the Xbox One first and second generation wireless controllers.

- 1 Plug the adapter into a compatible Xbox One controller.
- 2 Power on the Xbox One controller. It may take the adapter up to 10 seconds to boot up. The LED turns on for 2 seconds to indicate power.

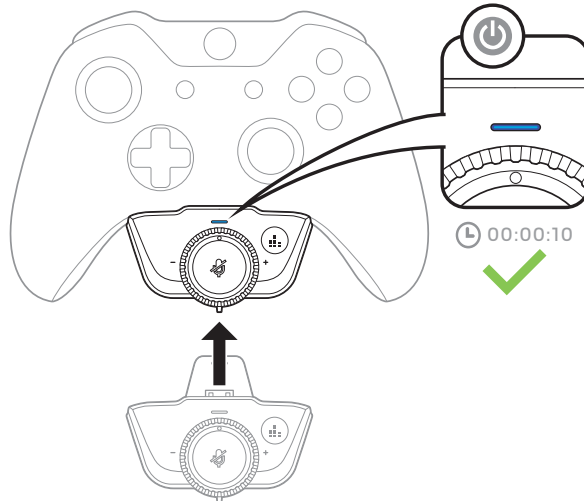

- 3 Connect a headset to the adapter in the 3.5 mm jack.
- 4 Choose how you want the dials to be configured. By default, the adapter is set to Balance mode. Press the EQ button for 2 seconds to switch between Balance and Independent mode.
  - **Balance mode** In Balance mode (blue LED) the top dial controls master volume and the bottom dial balances game and chat.



- **Independent mode** In Independent (green LED) mode the game and chat channels are split; the top dial controls game volume and the bottom dial controls chat volume.



- 5 Choose an EQ setting. Cycle through the EQ modes by tapping the EQ button.

Tap the EQ button and hear	EQ mode
one tone	Pure EQ maintains high frequencies.
two tones	Intensify EQ emphasizes mid-range sounds.
three tones	Seismic EQ boosts bass.

- 6 **Optional** Plug a device into the 3.5 mm jack, if you want to listen music while gaming.

# Support

---

<b>EN</b> Tel: 0800 410014	<b>FI</b> Tel: 0800 117095	<b>NO</b> Tel: 80011336
<b>AR</b> Tel: +44 (0)1793 842443*	<b>FR</b> Tel: 0800 945770	<b>PL</b> Tel: +44 (0)1793 842443*
<b>CS</b> Tel: +44 (0)1793 842443*	<b>GA</b> Tel: 1800 551 896	<b>PT</b> Tel: 0800 84 45 17
<b>DA</b> Tel: 80 88 46 10	<b>HE</b> Tel: +44 (0)1793 842443*	<b>RO</b> Tel: +44 (0)1793 842443*
<b>DE</b> Deutschland 0800 9323 400 Österreich 0800 242 500 Schweiz 0800 932 340	<b>HU</b> Tel: +44 (0)1793 842443*	<b>RU</b> Tel: 8-800-100-64-14 Tel: +44 (0)1793 842443*
<b>EL</b> Tel: +44 (0)1793 842443*	<b>IT</b> Tel: 800 950934	<b>SV</b> Tel: 0200 21 46 81
<b>ES</b> Tel: 900 803 666	<b>NL</b> NL 0800 7526876 BE 0800 39202 LUX 800 24870	<b>TR</b> Tel: +44 (0)1793 842443*

---

*\*Support in English*

For warranty details, go to [plantronics.com/warranty](http://plantronics.com/warranty).

## NEED MORE HELP?

[plantronics.com/support](http://plantronics.com/support)

**plantronics®**

Simply Smarter Communications™

### **Plantronics, Inc.**

345 Encinal Street  
Santa Cruz, CA 95060  
United States

### **Plantronics BV**

South Point Building C  
Scorpius 140  
2132 LR Hoofddorp, Netherlands

© 2015 Plantronics, Inc. Plantronics is a trademark of Plantronics, Inc. registered in the US and other countries, and Plantronics LX1 is a trademark of Plantronics, Inc. All other trademarks are the property of their respective owners.

Patents pending.

205961-06 (10.15)